

Yamaha ATV Backup Light Kit

Installation Instructions for Part No. 66005



Hardware Included:

- 1 – 12W LED FLOOD LIGHT
- 1 – ATV Wire Harness w/switch
- 1 – 12v Accessory adaptor
- 1 – 12" Wire w/No. 6 ring terminal
- 1 – 12" Wire w/Yamaha connector
- 2 – Light Clamps
- 4 – Short allen Screws (7/8" tubing)
- 4 – Long allen Screws (1" tubing)
- 2 – Short Phillips screw (light)
- 2 – Male Spade terminals
- 2 – T-Taps
- 4 – Zip Ties

Tools Required:

- Drill
- 3/4" drill bit
- Phillips screwdriver
- 10mm socket
- Ratchet
- 4mm allen wrench



PLEASE READ ALL INSTRUCTIONS CAREFULLY PRIOR TO INSTALLATION

Attention: The assembly of this product can be complicated and requires good technical understanding. If you are not sure on how to do this or have a vehicle with complex electronics, have a service center perform the installation.

PowerMadd accepts no liability for damages caused by improper installation. Before proceeding familiarize yourself with all the parts contained in the Yamaha ATV Backup light kit and the wiring schematic. Reference parts list and schematic.

NOTE: All parts may not be used depending on application.

Wiring Diagram

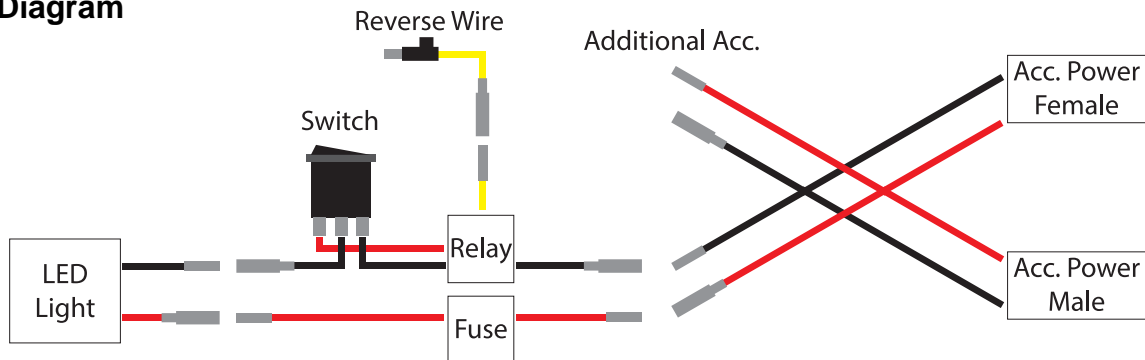

STEP 1: 12V switch

Use the supplied templates (**SEE PHOTOS 1&2**) to Drill a 3/4" hole and with a small file create a slot for the indexing tab on the 12-volt switch. Remove wires from the 12V switch and press into place. Take note of the location of the wires on the back of the 12V switch. These need to be replaced in the same location. The relay will also need to be secured near this location. Make certain the relay is clear of the moving and hot parts of your ATV.





Fits: 2007-15 Grizzly 700 & 2009-14 Grizzly 550



Fits: 2016-19 Grizzly 700 & Kodiak 700

STEP 2: Locate 12 volt accessory plug connector

You will find the 12 volt accessory plug connector located in the front of the ATV. Underneath the front rack. The plug is typically white or grey in color. To verify you have the correct plug, you can test for 12 DC Volts with a multimeter. Disconnect the connector and plug-in the PowerMadd accessory adaptor. Route the wires labeled "ground" and "+" toward the PowerMadd accessory adaptor. Plug the wire labeled "ground" into the one of the black wires from the PowerMadd accessory adaptor. Plug the wire labeled "+" into one of the red wires from the PowerMadd accessory plug. The extra red and black wires are for other accessories such as LED lights or a winch. **SEE PHOTO 3**



STEP 3: Reverse wire

What year and model are your Yamaha ATV?

2002 grizzly 660/700 and up use the 12" wire w/Yamaha connector.

All others use the 12" wire w/No. 6 ring terminal.

2002 grizzly 660/700 and up remove the right side panels and clutch air duct to gain access to the reverse switch which is located on the rear-middle of the engine cases. Refer to your owners manual on how to remove the plastic covers. **SEE PHOTO 4**

Unplug connector to reverse switch and replace with PowerMadd's 2-way Yamaha electrical connector. Reinstall OEM Yamaha connector. **SEE PHOTO 4**

All others

Gain access to the rear-middle area of the engine cases. This will require removal of seat and air box. Determine which of the multi-switches operates the reverse light. To do this use a volt meter and switch ATV in and out of reverse to see how the multi-meter reacts. Once you have determined the correct switch, connect the No. 6 ring terminal to the switch. On 2002 Kodiak **SEE PHOTO 5**

STEP 4: Securing LED light

Connect the backup light to the back of the ATV on the luggage rack using the included clamps. The light can be attached in four different orientations. Determine which is best for your situation considering your luggage and rack use. 2016 and new ATV's have 1" tubing and use the longer screws. All others have 7/8" tubing and use the shorter screws. The small Phillips button head screws are used to attach the LED light to the brackets. **SEE PHOTOS 6,7,8 & 9**

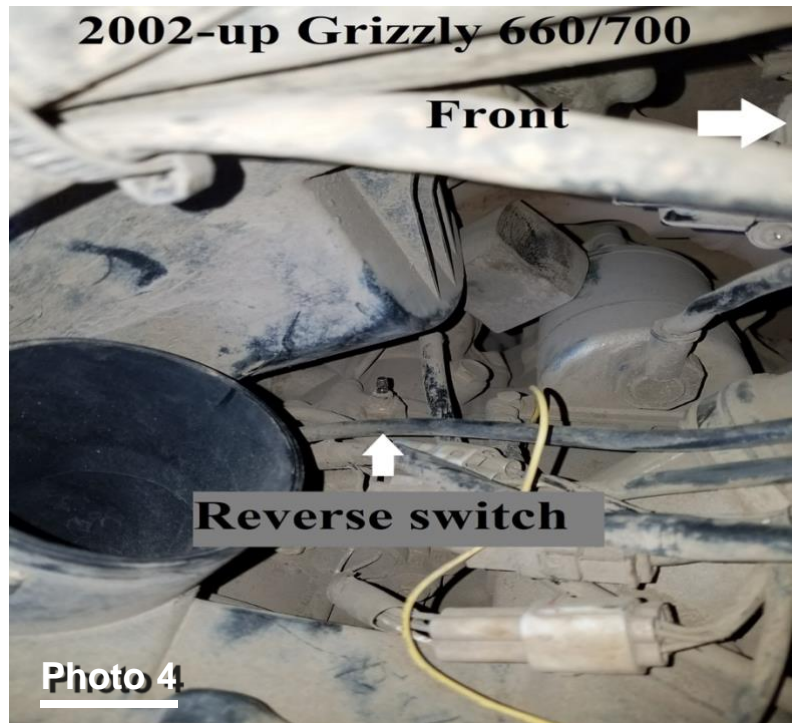

STEP 5: Hooking up the wires

Route the backup light wire from the harness to your backup light and connect the wires. Make sure you avoid all moving and hot surfaces. Secure wire using the included zip ties. Route the yellow wire labeled "reverse switch" down toward the reverse switch. Make sure you avoid moving and hot surfaces. Connect the wire to the reverse switch that you installed in step 3. Secure wires using the included zip ties.

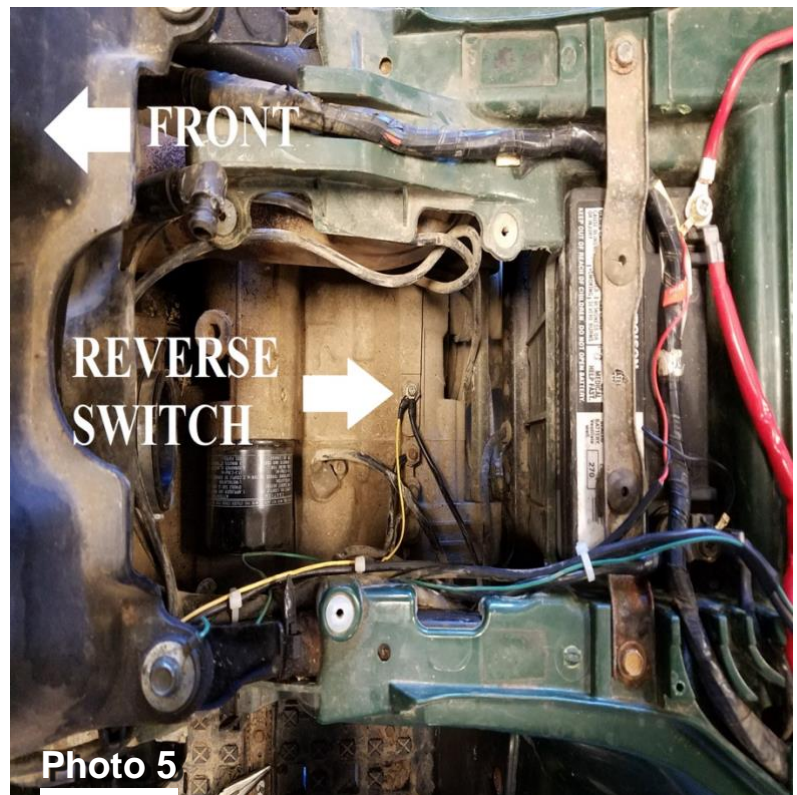

Photo 6



Photo 7



Photo 8



Photo 9

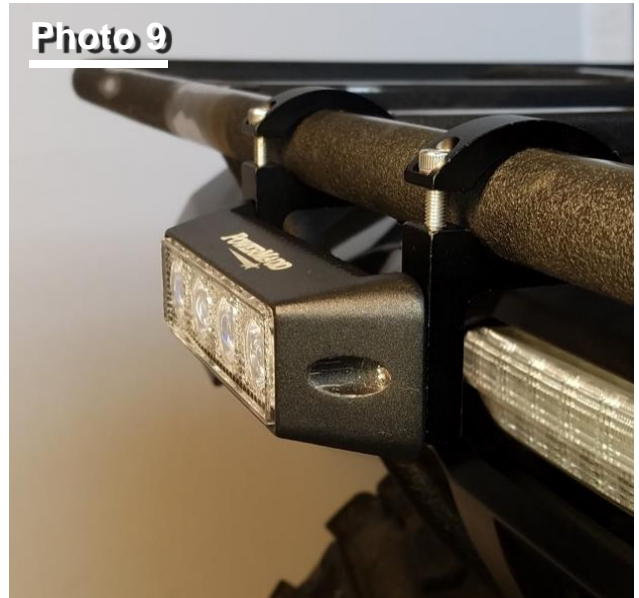

If not using the 12v accessory adaptor you can use the included T-tap connectors to tap into power and ground wires

T-Taps Install Instructions:

1. Place wire in open channel of the T Tap.
2. Fold T Tap connector body until element contacts wire.
3. Crimp T Tap closed with pliers. Find a safe location to secure the LED control box away from heat sources and impact damage. Secure LED control box using supplied zip ties.

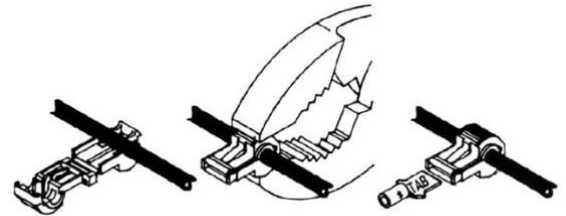

NOTE: Instructions are posted on our web site www.powermadd.com in full color. Click on fitment/instructions.

LIMITED WARRANTY

PowerMadd guarantees its products against defects in material and workmanship for a period of twelve (12) months from the original date of purchase. **POWERMADD** shall not be liable for damage or injury caused by defective materials or workmanship. **POWERMADD** may elect to repair or replace this product, but is the sole judge of any defects in their product. This warranty does not cover any labor costs to remove or reinstall this product and is effect for one year from the original purchase date.

Note: When printing, DO NOT SCALE

2016-2019 Grizzly 700
and Kodiak 700

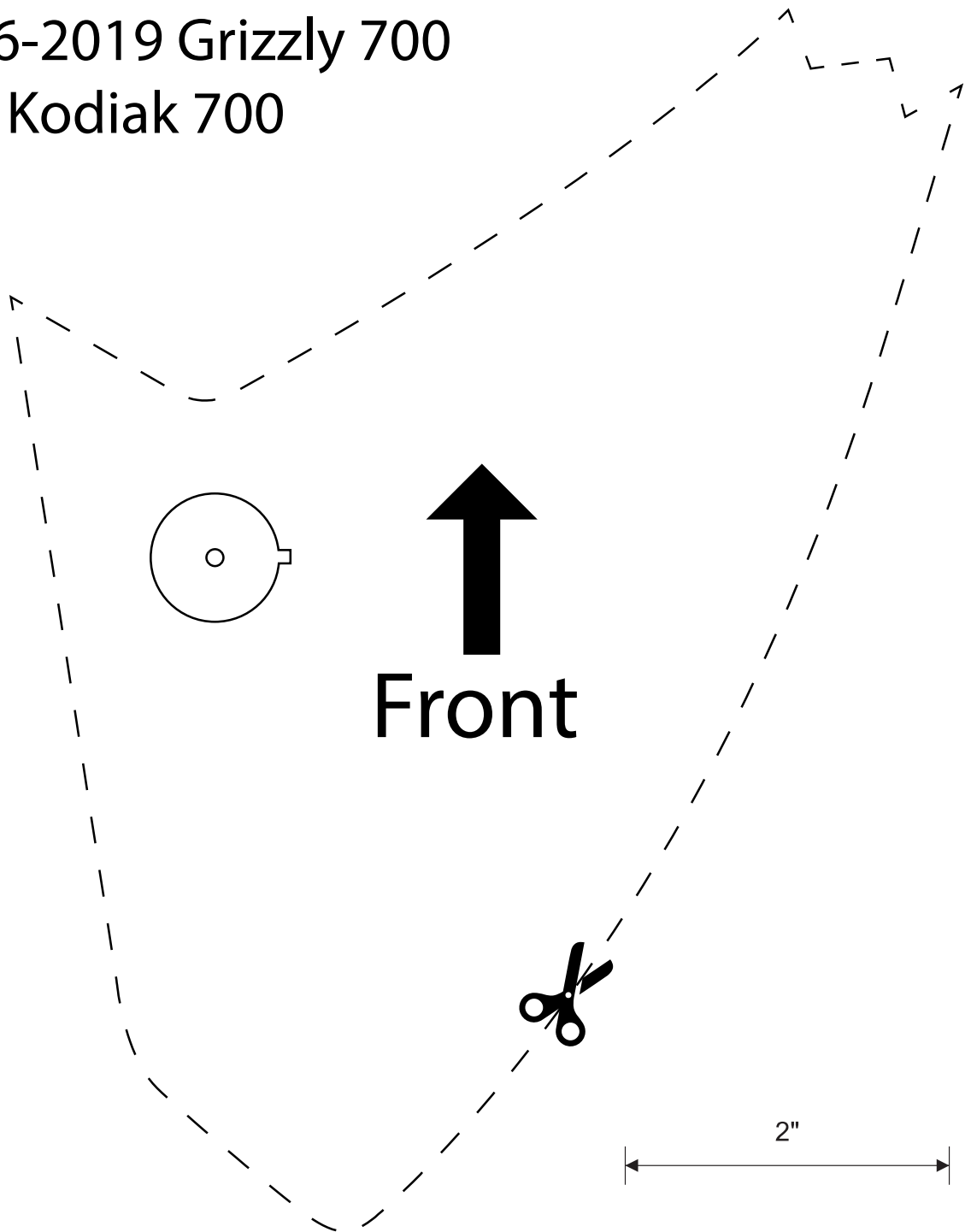

Cut and place template on right side of machine as shown in photo.

Note: When printing, DO NOT SCALE

2007-2015 Grizzly 700

2009-2014 Grizzly 550

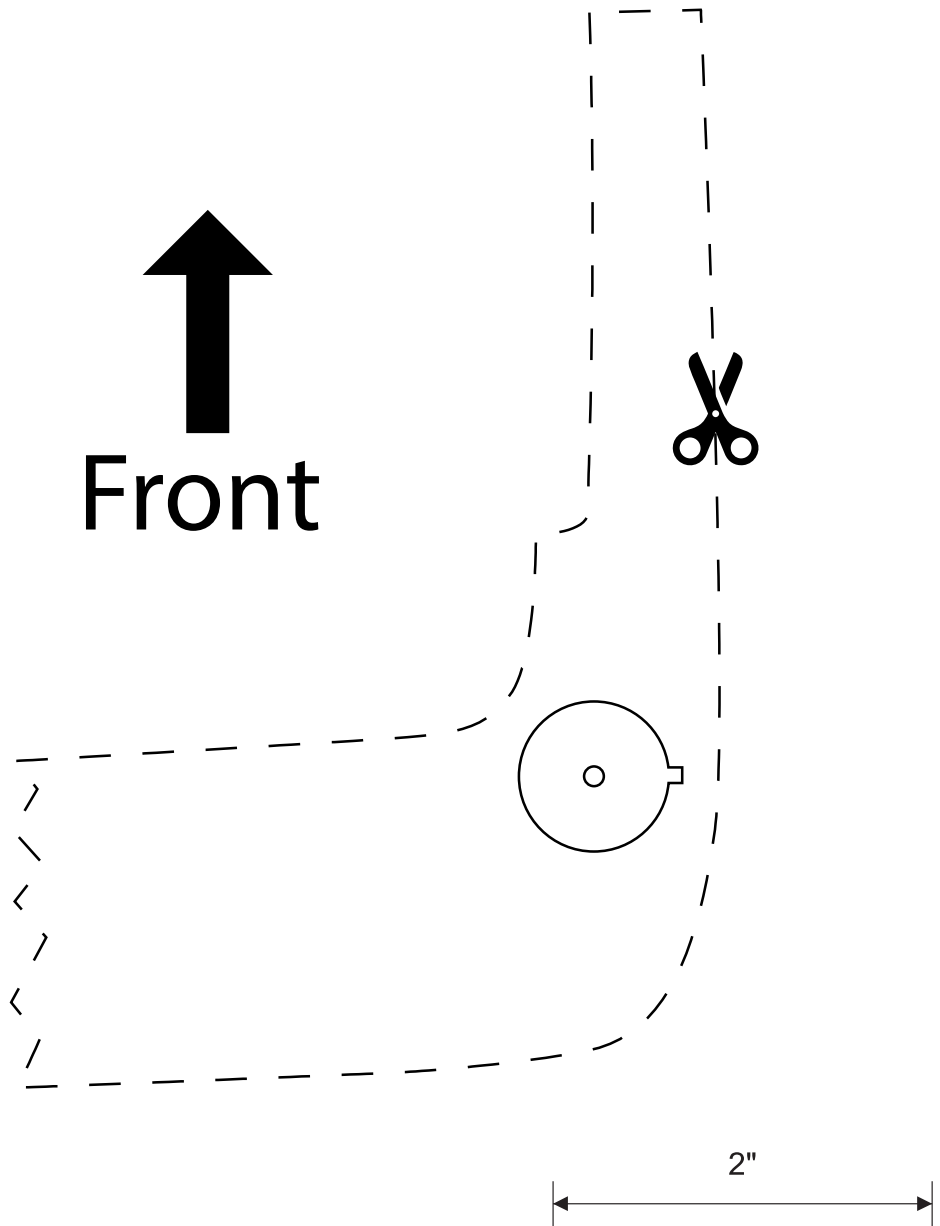

Cut and place template on right side of machine as shown in photo.